

job name:
 type:

na.row.r™ ceiling spec sheet 90CRI

material

2"dia smooth extruded aluminum outer housing in six lengths available in 15 standard powder coat paint finishes listed below.

LED

COB in 2700K, 3000K, 3500K, or 4000K 90+ cri standard rated >36,000 hours L70 (6.8K) per LM-80 test data, and 71,000 hours projected life per IES TM-21.

downlight optics

Khatod® Cosmo 50mm dia 16mm high (RoHS compliant) available in 12° spot, 25° medium, 38° wide

driver

constant current, class P, class 2 power unit, class A sound rating, universal input (120-277V) programmable driver, 5% minimum dimming level, PF >0.90. protections include short circuit, input/output isolation and surge protection (3KV). wired for 0-10v dimming from factory.

mounting

standard

driver in junction box (requires 2 1/8" deep electrical box). 5" dia canopy painted to match fixture.

remote enclosure (.LV) (optional)

the standard driver can be remote mounted up to 33ft from the LED. suspension length should be considered in distance. remote enclosure supplied. for distances greater than 33ft consult factory. for Chicago Plenum installation consult factory.

finish

select from 15 standard powder coat paint finishes listed below or specify RAL# for custom colors.

emergency

if required, recommend use of inverter (by other).



catalog number

--	--	--	--	--	--

size	beam	CCT	lumens	painting finish	options	
C3906 driver in j-box	S 12° spot	27 2700K	L1 360 lm	AP anodized paint BS brass BU blue BZ bronze CP champagne FB flat black GM gun metal MB military blue MW matte white OR orange RD red SB satin black SS satin silver TG textured gray YO yellow		
C3906.LV remote enclosure 2"dia X 6.25"ht	M 25° med	30 3000K	L2 630 lm			
C3912 driver in j-box	W 38° wide	35 3500K	L3 900 lm			
C3912.LV remote enclosure 2"dia X 12.25"ht		40 4000K	H1 1265 lm			
C3918 driver in j-box			H2 1805 lm			
C3918.LV remote enclosure 2"dia X 18.25"ht						
C3924 driver in j-box						
C3924.LV remote enclosure 2"dia X 24.25"ht						
C3936* driver in j-box						
C3936.LV* remote enclosure 2"dia X 36.25"ht						
C3948* driver in j-box						
C3948.LV* remote enclosure 2"dia X 48.25"ht						
					premium finish	
					RAL specify RAL#	



.LV
remote enclosure

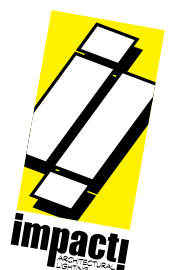

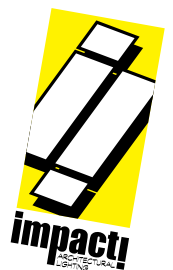
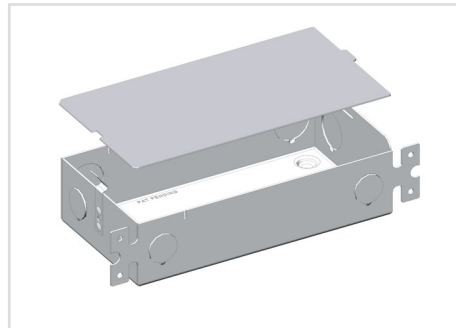
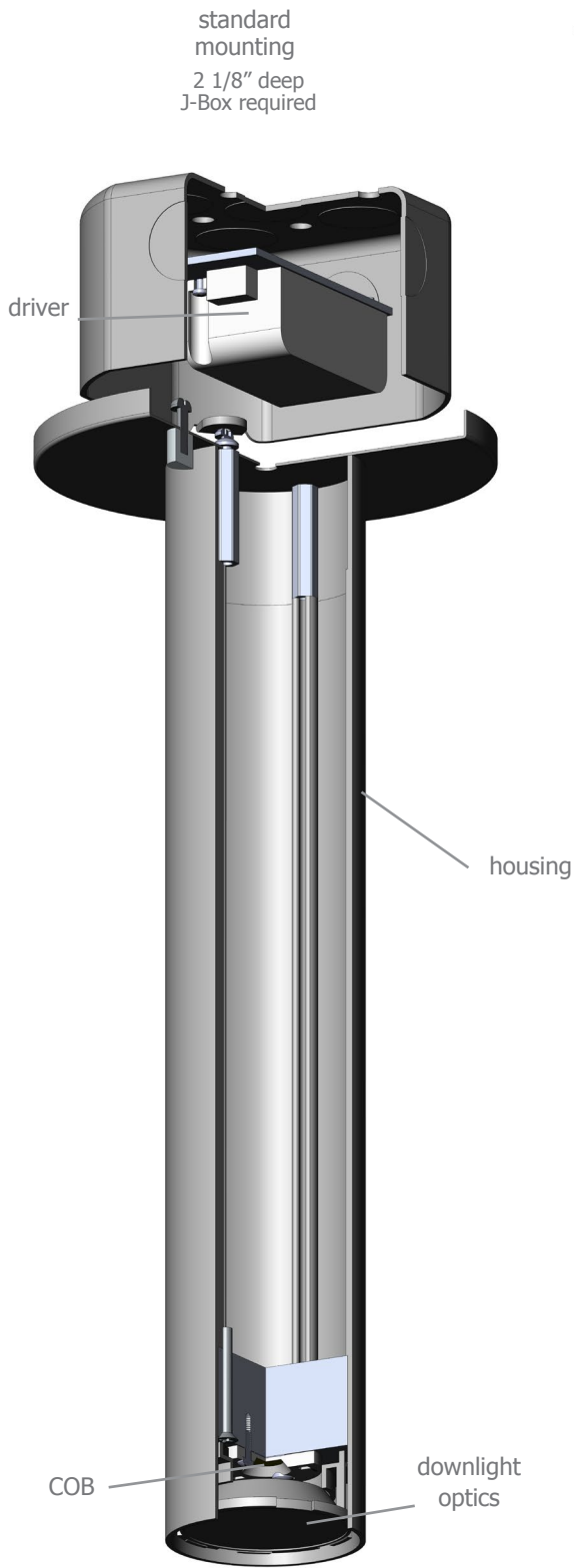

Calculation Table

Consult factory for applications assistance



Cat No	Delivered* Lumens	Watts 120V / 277V	IES File #	LLF to be applied
L1	360	3	07222C spot	.30
			07222B med	.30
			07222A wide	.30
L2	630	6	07222C spot	.53
			07222B med	.53
			07222A wide	.53
L3	900	9	07222C spot	.76
			07222B med	.76
			07222A wide	.76
H1	1265	13	07222C spot	1.07
			07222B med	1.07
			07222A wide	1.07
H2	1805	19	07222C spot	1.52
			07222B med	1.52
			07222A wide	1.52

*delivered lumens based on 4000K, 90+ cri

The application of a Light Loss Factor is required to:

- match the lumen output for the power module specified
- incorporate the increased lumen output due to LED/Driver upgrades

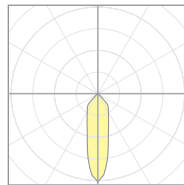

07222C
P39xx-S-40H1
S 12° spot

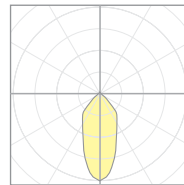

07222B
P39xx-M-40H1
M 25° med

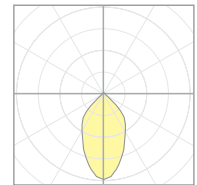

07222A
P39xx-W-40H1
W 38° wide

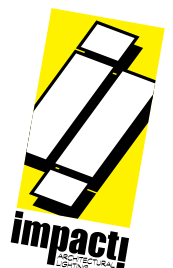

Powder Coat Paint Finishes

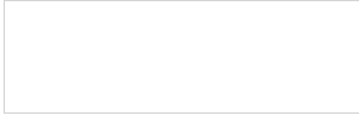

MW matte white

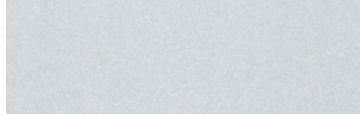

AP anodized paint



SS satin silver



TG textured gray

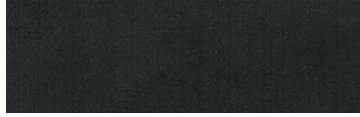

FB flat black



SB satin black

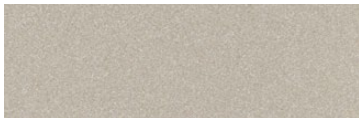

CP champagne

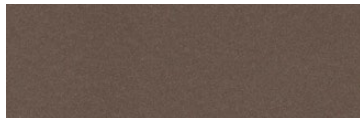

BZ bronze

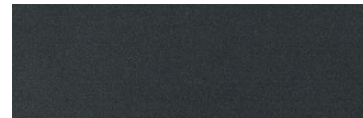

GM gun metal



OR orange 2011



BU blue 5017



BS brass



RD red 3020



YO yellow 1018



MB military blue

For accurate color verification, actual finish samples are available upon request.

Premium Finishes*



RAL#

*Available on select series. Consult product submittal for availability.

